















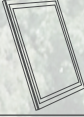

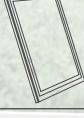
LED LIGHTING PRODUCTS
AYDINLATMA
ÜRÜNLERİ

www.makel.com.tr

LED LIGHTING PRODUCTS
AYDINLATMA
ÜRÜNLERİ



	Gece Lambası Led Night Lamp	1
	Buji Tipi Led Ampul Led Candle Type Bulb	2
	Mum Tipi Led Ampul Led Crooked Candle Type Bulb	3
	Led Ampul Led Bulb	4
	Led Slim Downlight Armatür Led Slim Downlight Luminaire	6
	Led Panel Armatür Led Panel Luminaire	8
	Clip in Led Panel Armatür Clip in Led Panel Luminaire	10
	Led Backlight Panel Armatür Led Backlight Panel Luminaire	11
	Led Projektör Led Floodlight	12
	360° Hareket Algılamalı Tavan Armatürü 360° Motion Sensor Ceiling Luminaire	13
	Tavan Tipi Varlık Dedektörü Ceiling Type Presence Detector	14
	Hareket Sensörü Motion Sensor	15
	Montaj Aparatları Installation Equipments	15
	LED Tüp Lamba Tubular LED Lamps	16
	Led Sürücü Led Driver	17

LED LIGHTING PRODUCTS
AYDINLATMA
ÜRÜNLERİ





LED LIGHTING PRODUCTS
AYDINLATMA
ÜRÜNLERİ



Gece Lambası

Led Night Lamp

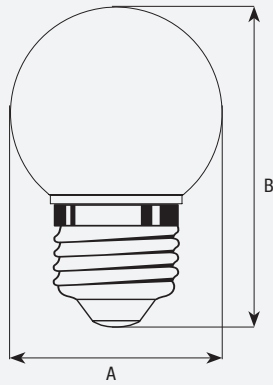

1

Barcode	Wattage	Color	Kelvin	PF	A (mm)	B (mm)	Box Qty
* BB01.0W-0127A	1	White	6500	> 0.30	45	68	100
BB01.0W-0327A	1	Red	-	> 0.15	45	68	100
BB01.0W-0427A	1	Blue	-	> 0.15	45	68	100
BB01.0W-0527A	1	Yellow	-	> 0.15	45	68	100
BB01.0W-0627A	1	Green	-	> 0.15	45	68	100

Buji Tipi Led Ampul

Led Candle Type Bulb

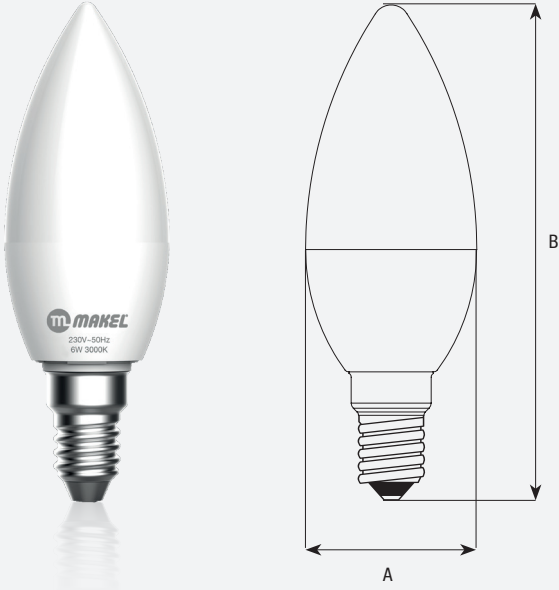

2

Işık Şiddeti Dağılım Eğrisi

Luminous Intensity Distribution Curve

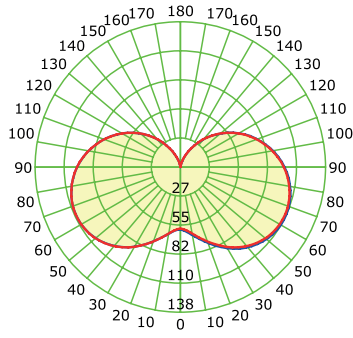

Konik Diyagram

Illuminance at a Distance

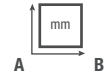
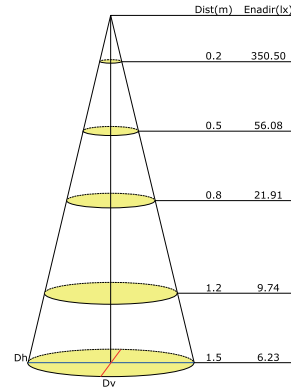

Model	Wattage	Lumen	lm/W	Color	Temperature	Voltage	Length (mm)	Width (mm)	Height (mm)	
BM03.0W-0214A	3	24	240	80	WW	3000	220-240V / 50-60Hz	36	105	100
BM03.0W-0114A	3	24	240	80	CW	6500	220-240V / 50-60Hz	36	105	100
BM06.0W-0214A	6	45	540	90	WW	3000	150-260V / 50-60Hz	38	110	100
BM06.0W-0114A	6	45	540	90	CW	6500	150-260V / 50-60Hz	38	110	100
BM06.0W-0814A	6	45	540	90	NW	4000	150-260V / 50-60Hz	38	110	100

WW	NW	CW
Sıcak Beyaz - Warm White	Gün Işığı - Neutral White	Soğuk Beyaz - Cold White

* Yukardaki grafikler 3W Buji Tipi Led Ampul için verilmiştir
* The above graphics belong to Led Candle Type Bulb 3W



Mum Tipi Led Ampul

Led Crooked Candle Type Bulb

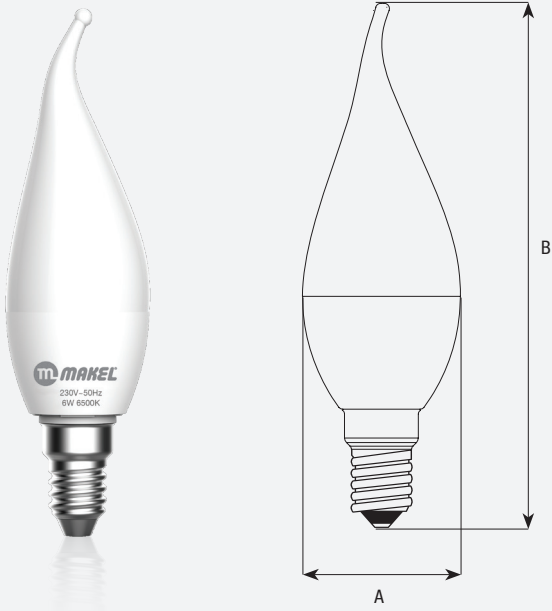

Işık Şiddeti Dağılım Eğrisi

Luminous Intensity Distribution Curve

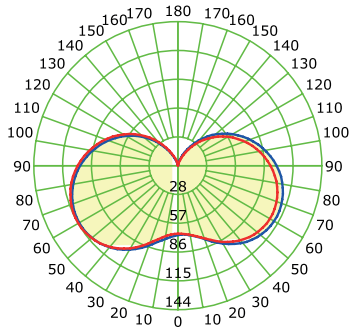

Konik Diyagram

Illuminance at a Distance

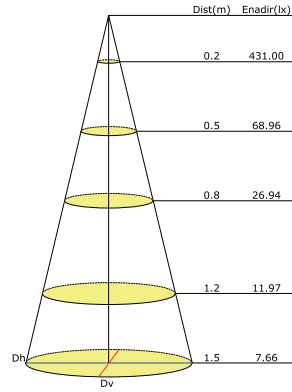

BG03.0W-0214A	3	24	240	80	WW	3000	220-240V / 50-60Hz	36	120	100
BG03.0W-0114A	3	24	240	80	CW	6500	220-240V / 50-60Hz	36	120	100
BG06.0W-0214A	6	45	540	90	WW	3000	150-260V / 50-60Hz	38	126	100
BG06.0W-0114A	6	45	540	90	CW	6500	150-260V / 50-60Hz	38	126	100
BG06.0W-0814A	6	45	540	90	NW	4000	150-260V / 50-60Hz	38	126	100

WW	NW	CW
Sıcak Beyaz - Warm White	Gün Işığı - Neutral White	Soğuk Beyaz - Cold White

* Yukarıdaki grafikler 3W Mum Tipi Led Ampul için verilmiştir
 * The above graphics belong to Led Crooked Candle Type Bulb 3W

Led Ampul

Led Bulb



4



Model	Wattage	LED W	Lumen	Lm/W	Color	Kelvin	Voltage	A	B	Box
BC03.0W-0227A	3	25	250	83	WW	3000	220 - 240 / 50-60Hz	50	90	100
BC03.0W-0827A	3	25	250	83	NW	4000	220 - 240 / 50-60Hz	50	90	100
BC03.0W-0127A	3	26	270	90	CW	6500	220 - 240 / 50-60Hz	50	90	100
BC05.0W-0227M	5	39	450	90	WW	3000	150 - 260V / 50-60Hz	60	107	100
BC05.0W-0827M	5	39	450	90	NW	4000	150 - 260V / 50-60Hz	60	107	100
BC05.0W-0127M	5	41	480	96	CW	6500	150 - 260V / 50-60Hz	60	107	100
BC06.0W-0227M	6	44	540	90	WW	3000	150 - 260V / 50-60Hz	60	107	100
BC06.0W-0827M	6	44	540	90	NW	4000	150 - 260V / 50-60Hz	60	107	100
BC06.0W-0127M	6	45	550	92	CW	6500	150 - 260V / 50-60Hz	60	107	100
BC07.0W-0227M	7	51	660	94	WW	3000	150 - 260V / 50-60Hz	60	107	100
BC07.0W-0827M	7	51	660	94	NW	4000	150 - 260V / 50-60Hz	60	107	100
BC07.0W-0127M	7	52	670	96	CW	6500	150 - 260V / 50-60Hz	60	107	100
BC08.0W-0227M	8	60	810	101	WW	3000	150 - 260V / 50-60Hz	60	107	100
BC08.0W-0827M	8	60	810	101	NW	4000	150 - 260V / 50-60Hz	60	107	100
BC08.0W-0127M	8	61	820	103	CW	6500	150 - 260V / 50-60Hz	60	107	100

WW	NW	CW
Sıcak Beyaz - Warm White	Gün Işığı - Neutral White	Soğuk Beyaz - Cold White

Işık Şiddeti Dağılım Eğrisi

Luminous Intensity Distribution Curve

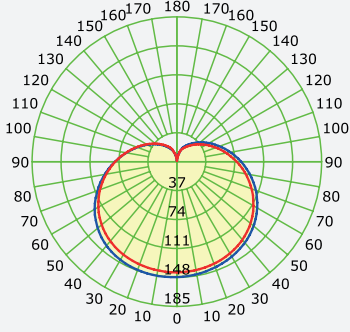

Konik Diyagram

Illuminance at a Distance

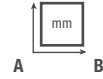
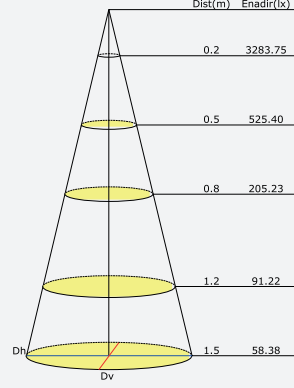

Model	9	64	870	97	WW	3000	150 - 260V / 50-60Hz	62	110	100
BC09.0W-0227M	9	64	870	97	NW	4000	150 - 260V / 50-60Hz	62	110	100
BC09.0W-0827M	9	66	900	100	CW	6500	150 - 260V / 50-60Hz	62	110	100
BC10.0W-0227M	10	70	980	98	WW	3000	150 - 260V / 50-60Hz	62	110	100
BC10.0W-0827M	10	70	980	98	NW	4000	150 - 260V / 50-60Hz	62	110	100
BC10.0W-0127M	10	72	1010	101	CW	6500	150 - 260V / 50-60Hz	62	110	100
BC12.0W-0227M	12	80	1140	95	WW	3000	150 - 260V / 50-60Hz	62	110	100
BC12.0W-0827M	12	80	1140	95	NW	4000	150 - 260V / 50-60Hz	62	110	100
BC12.0W-0127M	12	82	1180	98	CW	6500	150 - 260V / 50-60Hz	62	110	100
BC15.0W-0227M	15	107	1400	83	WW	3000	150 - 260V / 50-60Hz	80	142	100
BC15.0W-0827M	15	107	1400	83	NW	4000	150 - 260V / 50-60Hz	80	142	100
BC15.0W-0127M	15	107	1400	83	CW	6500	150 - 260V / 50-60Hz	80	142	100

WW	NW	CW
Sıcak Beyaz - Warm White	Gün Işığı - Neutral White	Soğuk Beyaz - Cold White

* Yukardaki grafikler 8W Led Ampul için verilmiştir
 * The above graphics belong to Led Bulb 8W

Led Slim Downlight Armatür

Led Slim Downlight Luminaire

Işık Şiddeti Dağılım Eğrisi

Luminous Intensity Distribution Curve

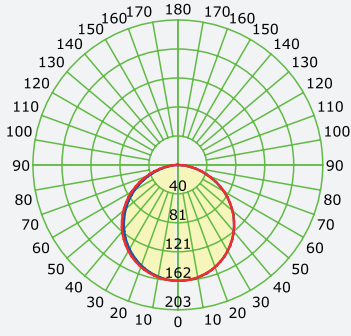

Konik Diyagram

Illuminance at a Distance

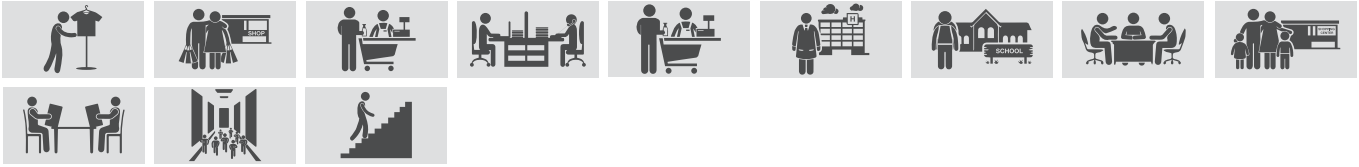
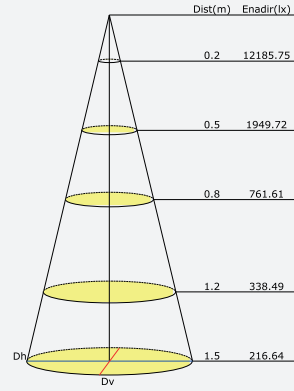

A



B

C



Model	Wattage (W)	Lumen (lm)	Color Temperature (Kelvin)	Voltage (V)	A (mm)	B (mm)	C (mm)	Box Qty
DC18.0W-02005	18	1.400	WW	100-240V / 50-60Hz	225	20,6	210	24
DC18.0W-08005	18	1.400	NW	100-240V / 50-60Hz	225	20,6	210	24
DC18.0W-01005	18	1.450	CW	100-240V / 50-60Hz	225	20,6	210	24
DC24.0W-02005	24	1.800	WW	100-240V / 50-60Hz	300	21,8	290	24
DC24.0W-08005	24	1.800	NW	100-240V / 50-60Hz	300	21,8	290	24
DC24.0W-01005	24	1.900	CW	100-240V / 50-60Hz	300	21,8	290	24
* DC12.0W-02015	12	900	WW	100-240V / 50-60Hz	170	20,6	157	24
* DC12.0W-08015	12	900	NW	100-240V / 50-60Hz	170	20,6	157	24
* DC12.0W-01015	12	900	CW	100-240V / 50-60Hz	170	20,6	157	24
* DC18.0W-02015	18	1.400	WW	100-240V / 50-60Hz	225	20,6	210	24
* DC18.0W-08015	18	1.400	NW	100-240V / 50-60Hz	225	20,6	210	24
* DC18.0W-01015	18	1.450	CW	100-240V / 50-60Hz	225	20,6	210	24
* DC24.0W-02015	24	1.800	WW	100-240V / 50-60Hz	300	21,8	290	24
* DC24.0W-08015	24	1.800	NW	100-240V / 50-60Hz	300	21,8	290	24
* DC24.0W-01015	24	1.900	CW	100-240V / 50-60Hz	300	21,8	290	24

* Acil durum kiti içermektedir.
* Includes emergency kit.

WW	NW	CW
Sıcak Beyaz - Warm White	Gün Işığı - Neutral White	Soğuk Beyaz - Cold White

* Yukardaki grafikler 18W Slim Downlight Armatür için verilmiştir
* The above graphics belong to Led Slim Downlight Luminaire 18W

Led Panel Armatür

Led Panel Luminaire

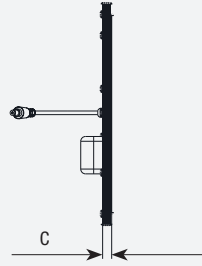
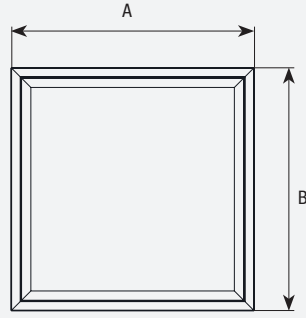

8



A



B

C



PC16.0W-02006	16	1.300	81	WW	3000K	150-260V / 50-60Hz	295	295	9	6
PC16.0W-08006	16	1.300	81	NW	4000K	150-260V / 50-60Hz	295	295	9	6
PC16.0W-01006	16	1.300	81	CW	6500K	150-260V / 50-60Hz	295	295	9	6
PC24.0W-02007	22	1.900	86	WW	3000K	150-260V / 50-60Hz	295	595	9	6
PC24.0W-08007	22	1.900	86	NW	4000K	150-260V / 50-60Hz	295	595	9	6
PC24.0W-01007	22	1.900	86	CW	6500K	150-260V / 50-60Hz	295	595	9	6
PC36.0W-02009	36	3.100	86	WW	3000K	150-260V / 50-60Hz	295	1195	9	6
PC36.0W-08009	36	3.100	86	NW	4000K	150-260V / 50-60Hz	295	1195	9	6
PC36.0W-01009	36	3.100	86	CW	6500K	150-260V / 50-60Hz	295	1195	9	6
PC48.0W-02009	48	4.100	85	WW	3000K	150-260V / 50-60Hz	295	1195	9	6
PC48.0W-08009	48	4.100	85	NW	4000K	150-260V / 50-60Hz	295	1195	9	6
PC48.0W-01009	48	4.100	85	CW	6500K	150-260V / 50-60Hz	295	1195	9	6

WW	NW	CW
Sıcak Beyaz - Warm White	Gün Işığı - Neutral White	Soğuk Beyaz - Cold White

Led Panel Armatür

Led Panel Luminaire

Işık Şiddeti Dağılım Eğrisi

Luminous Intensity Distribution Curve

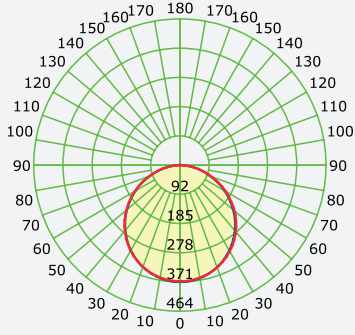

Clip in Led Panel Armatür

Clip in Led Panel Luminaire

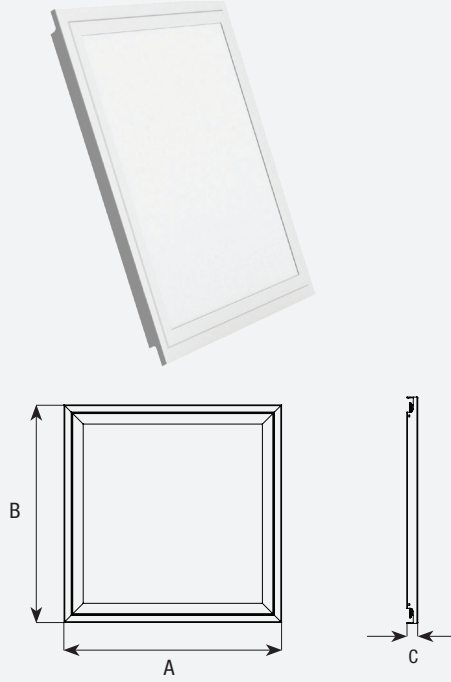

Işık Şiddeti Dağılım Eğrisi

Luminous Intensity Distribution Curve

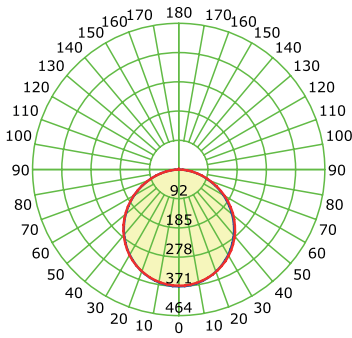

Konik Diyagram

Illuminance at a Distance

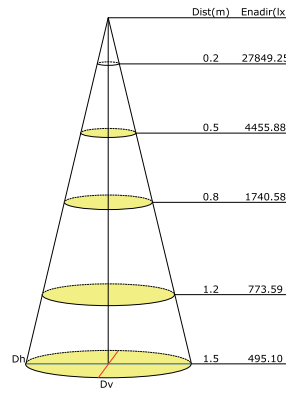

A

B

C



Model	A	B	C	Box						
PC16.0W-02014	16	1.300	81	WW	3000K	150-260V / 50-60Hz	295	295	9	6
PC16.0W-08014	16	1.300	81	NW	4000K	150-260V / 50-60Hz	295	295	9	6
PC16.0W-01014	16	1.300	81	CW	6500K	150-260V / 50-60Hz	295	295	9	6
PC36.0W-02022	36	3.200	89	WW	3000K	150-260V / 50-60Hz	595	595	9	6
PC36.0W-08022	36	3.200	89	NW	4000K	150-260V / 50-60Hz	595	595	9	6
PC36.0W-01022	36	3.300	92	CW	6500K	150-260V / 50-60Hz	595	595	9	6

WW	NW	CW
Sıcak Beyaz - Warm White	Gün Işığı - Neutral White	Soğuk Beyaz - Cold White

* Yukardaki grafikler 36W Clip in Led Panel Armatür için verilmiştir
* The above graphics belong to Clip in Led Panel Luminaire 36W

Led Backlight Panel Armatür

Led Backlight Panel Luminaire

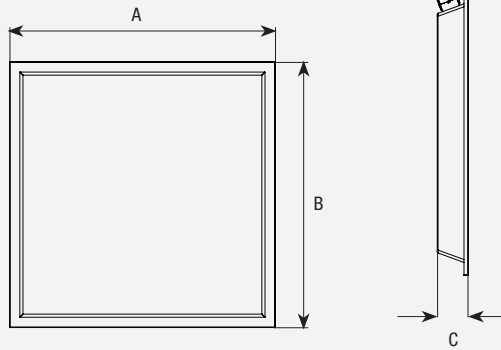

Işık Şiddeti Dağılım Eğrisi

Luminous Intensity Distribution Curve

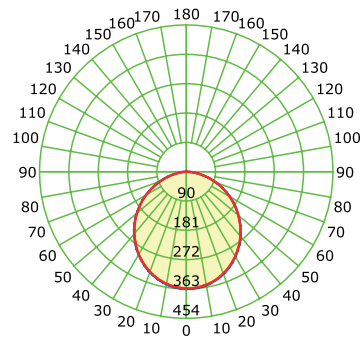

Konik Diyagram

Illuminance at a Distance

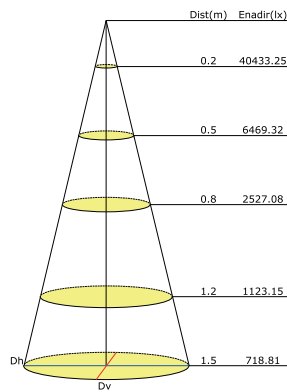

PL36.0W-02008	36W	3.900	108	WW	3000K	220-240V / 50-60Hz	595	595	67	6
PL36.0W-08008	36W	3.900	108	NW	4000K	220-240V / 50-60Hz	595	595	67	6
PL36.0W-01008	36W	4.000	111	CW	6500K	220-240V / 50-60Hz	595	595	67	6
PL48.0W-02008	48W	4.900	102	WW	3000K	220-240V / 50-60Hz	595	595	67	6
PL48.0W-08008	48W	4.900	102	NW	4000K	220-240V / 50-60Hz	595	595	67	6
PL48.0W-01008	48W	5.000	104	CW	6500K	220-240V / 50-60Hz	595	595	67	6

WW	NW	CW
Sıcak Beyaz - Warm White	Gün Işığı - Neutral White	Soğuk Beyaz - Cold White

* Yukardaki grafikler 36W Led Backlight Panel Armatür için verilmiştir
 * The above graphics belong to Led Backlight Panel Luminaire 36W

Led Projektör

Led Floodlight

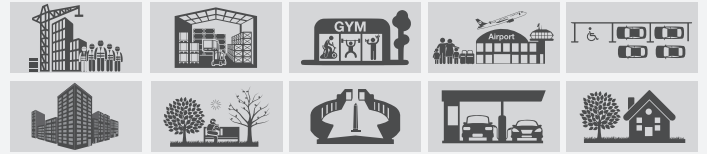
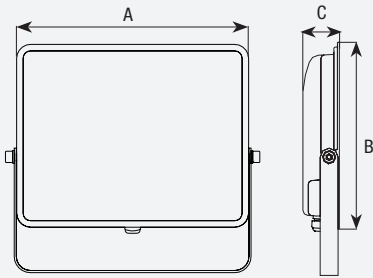

12

Işık Şiddeti Dağılım Eğrisi

Luminous Intensity Distribution Curve

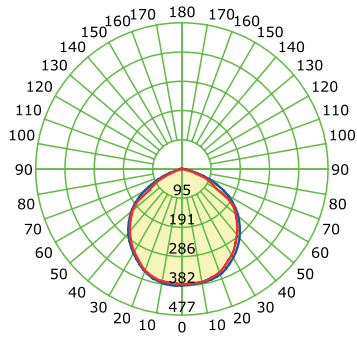

Konik Diyagram

Illuminance at a Distance

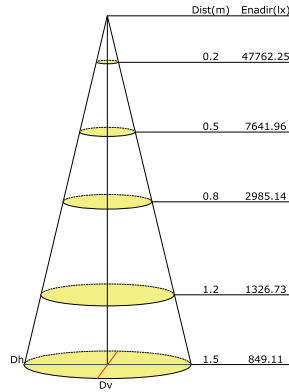

A

B

C



RC30.0W-02018	30W	3.000	100	WW	3000	220-240V / 50-60Hz	200	160	35	10
RC30.0W-01018	30W	3.300	110	CW	6500	220-240V / 50-60Hz	200	160	35	10
RC50.0W-02018	50W	4.750	95	WW	3000	220-240V / 50-60Hz	240	200	45	6
RC50.0W-01018	50W	5.000	100	CW	6500	220-240V / 50-60Hz	240	200	45	6
RC70.0W-02018	70W	6.700	95	WW	3000	220-240V / 50-60Hz	330	260	50	4
RC70.0W-01018	70W	7.000	100	CW	6500	220-240V / 50-60Hz	330	260	50	4
RC100.0W-02018	100W	9.500	95	WW	3000	220-240V / 50-60Hz	330	260	50	4
RC100.0W-01018	100W	10.000	100	CW	6500	220-240V / 50-60Hz	330	260	50	4

WW

CW

Sıcak Beyaz - Warm White

Soğuk Beyaz - Cold White

* Yukardaki grafikler 50W Led Projektör için verilmiştir
* The above graphics belong to Led Floodlight 50W

Tavan Tipi Varlık Dedektörü

Ceiling Type Presence Detector

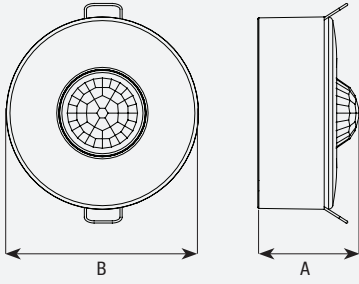

14

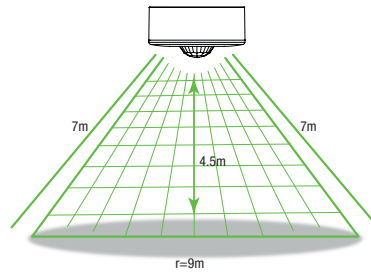

Barcode	✓	✓	✗	Max./Typ	Person	Thumbs Up	Stopwatch	Light Bulb	LED Light Bulb	A	B	Box	
9012341234571								Max. W	Max. W	mm			
10001A94	✓			16A	4,5 / 2,8	9 / 7 (2,8 yükseklik)	2,8m	9sn±1sn / 4dk± 10sn	1.200	400	46,3	88,3	60
10001A95		✓		16A	4,5 / 2,8	9 / 7 (2,8 yükseklik)	2,8m	9sn±1sn / 4dk± 10sn	1.200	400	46,3	88,3	60

Hareket Sensörü Motion Sensor

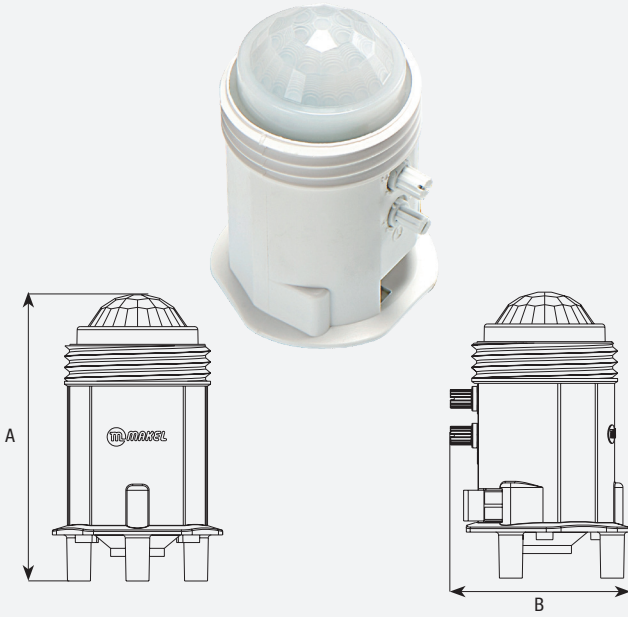

10000A75	220-240 V ~ 50/60Hz	4,5 / 2,8	9 / 7 (2,8 yükseklik)	2,8m	9sn±1sn / 4dk± 10sn	1.200	400	A 46,3 B 88,3	60

Montaj Aparatları

Installation Equipments

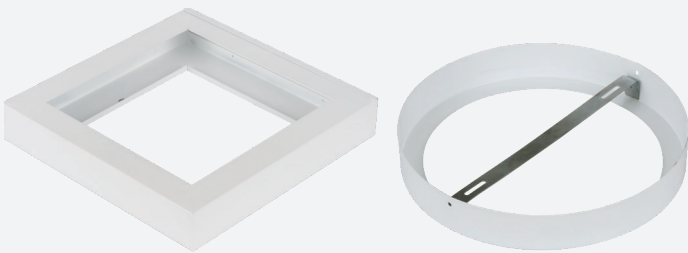

10000A66	RAL9016	A 300	B 300	C 50
10000A67	RAL9016	A 600	B 600	C 50
10000A72	RAL9016	A 300	B 600	C 50
10000A73	RAL9016	A 300	B 1200	C 50

LED Tüp Lamba

Tubular LED Lamps

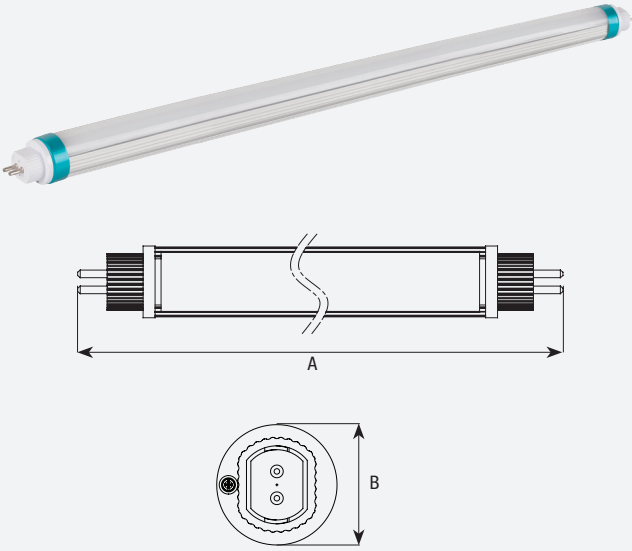

16

Işık Şiddeti Dağılım Eğrisi

Luminous Intensity Distribution Curve

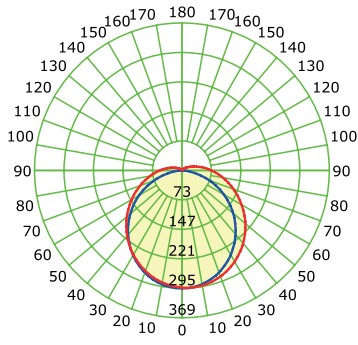

Konik Diyagram

Illuminance at a Distance

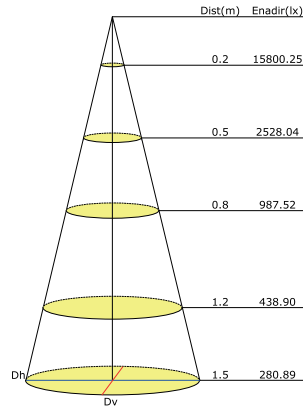

TC19.0W-01023



19



2.300



120



CW



6500



150-265V / 50-60Hz

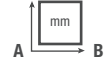

1500



23



60

CW

Soğuk Beyaz - Cold White

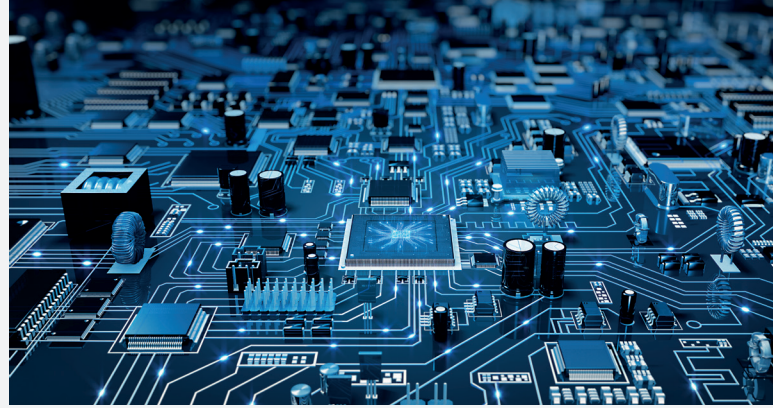
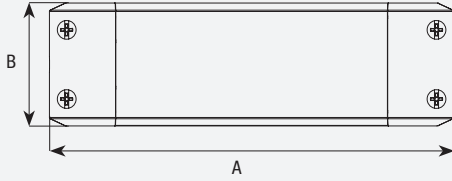
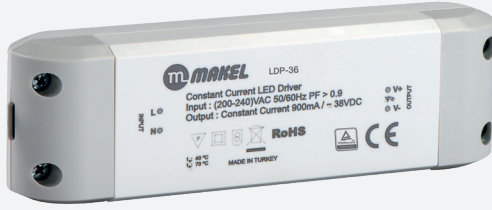

	V_{in}	I_{in}	PF	I_{out}	V_{out}	$V_{no-load}$	W	A	B	C	Protection
LDS-0306	220 - 240	0,07	>0,5	300	9 - 21	52	6	73,8	23,9	21,5	OVP, SCP, OTP
LDS-0912	220 - 240	0,14	>0,5	300	23 - 42	75	12	109	35,4	23,5	OVP, SCP, OTP
LDS-1518	220 - 240	0,18	>0,5	300	40 - 60	78	18	109	35,4	23,5	OVP, SCP, OTP
LDS-24	220 - 240	0,26	>0,5	300	60 - 80	101	24	140	42,5	31,5	OVP, SCP, OTP
LDP16	220 - 240	0,11	>0,9	450	27 - 42	78	19	140	42,5	31,5	OVP, SCP, OTP
LDP22	220 - 240	0,13	>0,9	550	27 - 42	78	23	140	42,5	31,5	OVP, SCP, OTP
LDP36	220 - 240	0,21	>0,9	900	27 - 42	53	38	140	42,5	31,5	OVP, SCP, OTP
LDP48	220 - 240	0,29	>0,9	1150	27 - 42	53	48	140	42,5	31,5	OVP, SCP, OTP
LDP-50	220 - 240	0,24	>0,9	1270	27 - 40	53	50	140	42,5	31,5	OVP, SCP, OTP

* Koruma



































OVP: Yüksek Voltaj Koruma
SCP: Kısa Devre Koruma
OTP: Yüksek Sıcaklık Koruma























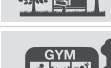







* Protection



























OVP: Over Voltage Protection
SCP: Short Circuit Protection
OTP: Over Temperature Protection

Açıklamalar

Descriptions

	Ürün Kodu Product Code		Armatür Montaj Yüksekliği Installation Height for Ceiling Luminaire		Koruma Protection
	Anma Gücü Rated Power		Algılama Mesafesi Detection Distance		AC Giriş Çalışma Gerilim Aralığı AC Input Voltage
	Renk Colour		Zaman Ayarı Time Setting		Giriş Akımı AC Input Current
	Renk Sıcaklığı Colour Temperature		Gün Işığı Ayarı Daylight Adjustment		DC Çıkış Akımı DC Output Current
	Güç Faktörü Power Factor		Acil Aydınlatma Emergency Lighting		DC Çıkış Gerilim Aralığı DC Output Voltage
	Boyutlar Dimensions		Acil Aydınlatma Süresi Emergency Lighting Time		Max. Çıkış Voltajı (yüksüz) Max. Output Voltage (no-load)
	Koli İçi Adet Piece in Box		Pil Türü Battery Type		Sıva Altı Flush Mounted
	Eşdeğer Watt Equivalent Watts		Pil Özellikleri Battery Characteristics		Sıva Üstü Surface Mounted
	Lümen Lumen		Güç Tüketimi Power Consumption		Montaj Yüksekliği Installation Height
	Etkinlik Faktörü Efficacy Factor		Max. Aydınlatma Yüğü Enkandasan Lamba Max. Lighting Load for Incandescent Bulb		Önerilen Tavan Yüksekliği Recommended Ceiling Height
	Renk İşareti Colour Sign		Max. Aydınlatma Yüğü Led Ampul Max. Lighting Load for Led Bulb		Algılama Etki Alanı Detection Influence Area
	Çalışma Gerilim Aralığı Operating Voltage Range		Anahtarlama Akımı Switching Current		

	Ofis Office		Butik Boutique		Okul School
	Hastane Hospital		Şantiye Construction Site		Veranda Veranda
	Ayna Mirror		Bina Cephesi Facade		Toplantı Odası Meeting Room
	Makyaj Odası Make-up Room		Depo Warehouse		Merdiven Stairs
	Ev Home		Park Park		Alışveriş Merkezi Shopping Center
	Laboratuvar Laboratory		Spor Salonu Gym		Tuvalet Toilet
	Koridor Corridor		Şehir Meydanı City Square		Mutfak Kitchen
	Market Market		Havalimanı Airport		Sanayi Tesisleri Industrial Plants
	Otel Hotel		Akaryakıt İstasyonu Gas Station		Restoran Restaurant
	Yatak Başı Bed Head		Otopark Car Park		
	Mağaza Store		Bina Çevresi Building Surrounding		

 Enerji Verimlilik Sınıfı Energy Efficiency Class	 Garanti Süresi Warranty Period	 Çalışma Gerilim Aralığı Operating Voltage Range	 EN 60598-2-5 Standardına Uygunluk Compliance with the Standard EN 60598-2-5
 Enerji Tasarrufu Energy Saving	 Led Led	 Anma Gerilimi Rated Voltage	 EN 60669-2-1 Standardına Uygunluk Compliance with the Standard EN 60669-2-1
 Ömür (20.000 saat) Lifetime (20.000 hours)	 Atık Elektrikli ve Elektronik Eşya Waste Electricity and Electronic Equipment	 TÜV Sertifikası TUV Certificate	 EN 62776 Standardına Uygunluk Compliance with the Standard EN 62776
 Ömür (50.000 saat) Lifetime (50.000 hours)	 IP20 Koruma Sınıfına Uygunluk Compliance with the Protection Class IP20	 Sınıf II Elektriksel Koruma Sınıfı Class II Electrical Protection Class	 EN 60598-2-1 Standardına Uygunluk Compliance with the Standard EN 60598-2-1
 Duy Tipi (E14) Base Type (E14)	 IP40 Koruma Sınıfına Uygunluk Compliance with the Protection Class IP40	 SELV Led Sürücü SELV Led Driver	 EN 62560 Standardına Uygunluk Compliance with the Standard EN 62560
 Duy Tipi (E27) Base Type (E27)	 IP65 Koruma Sınıfına Uygunluk Compliance with the Protection Class IP65	 Bağımsız Led Sürücü Independent Led Driver	 EN 60598-2-2 Standardına Uygunluk Compliance with the Standard EN 60598-2-2
 Başlama Süresi Starting Time	 Dim Edilemez Non-Dimmable	 Frekans Frequency	 EN 61347-1 Standardına Uygunluk Compliance with the Standard EN 61347-1
 Cıva İçeriği Mercury Content	 Açma Kapama Sayısı Switching Cycle	 Pili Türü Battery Type	 EN 61347-2-13 Standardına Uygunluk Compliance with the Standard EN 61347-2-13
 Renk Geri Verim İndeksi Color Rendering Index	 Güç Faktörü Power Faktör	 360° Algılama Etki Alanı Detection Area 360°	
 CE Direktiflerine Uygunluk Compliance with CE Directives	 TSE Uygunluk Compliance with TSE	 EAC Gümrük Birliği Sertifikası EAC Customs Union Certificate	

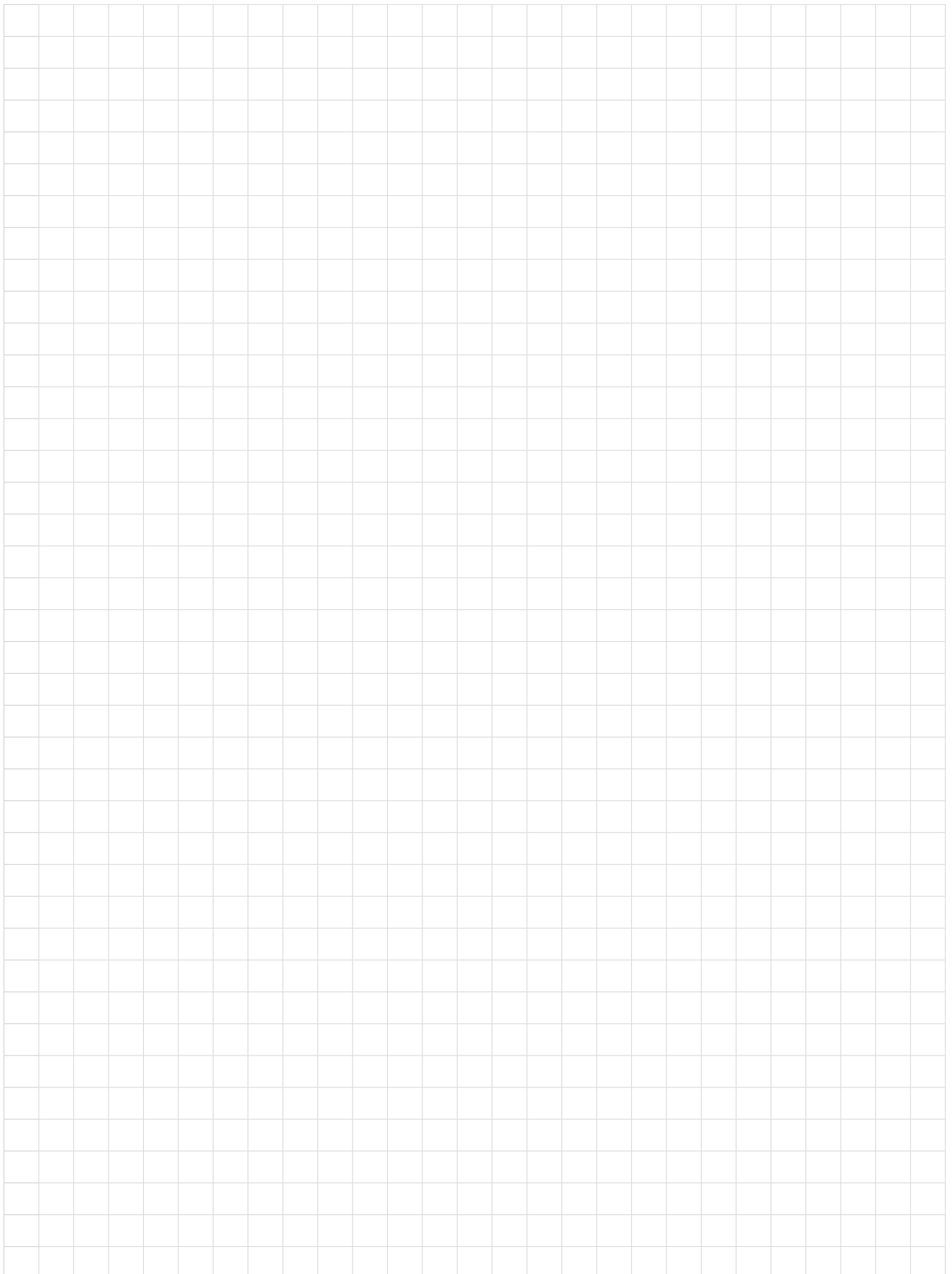

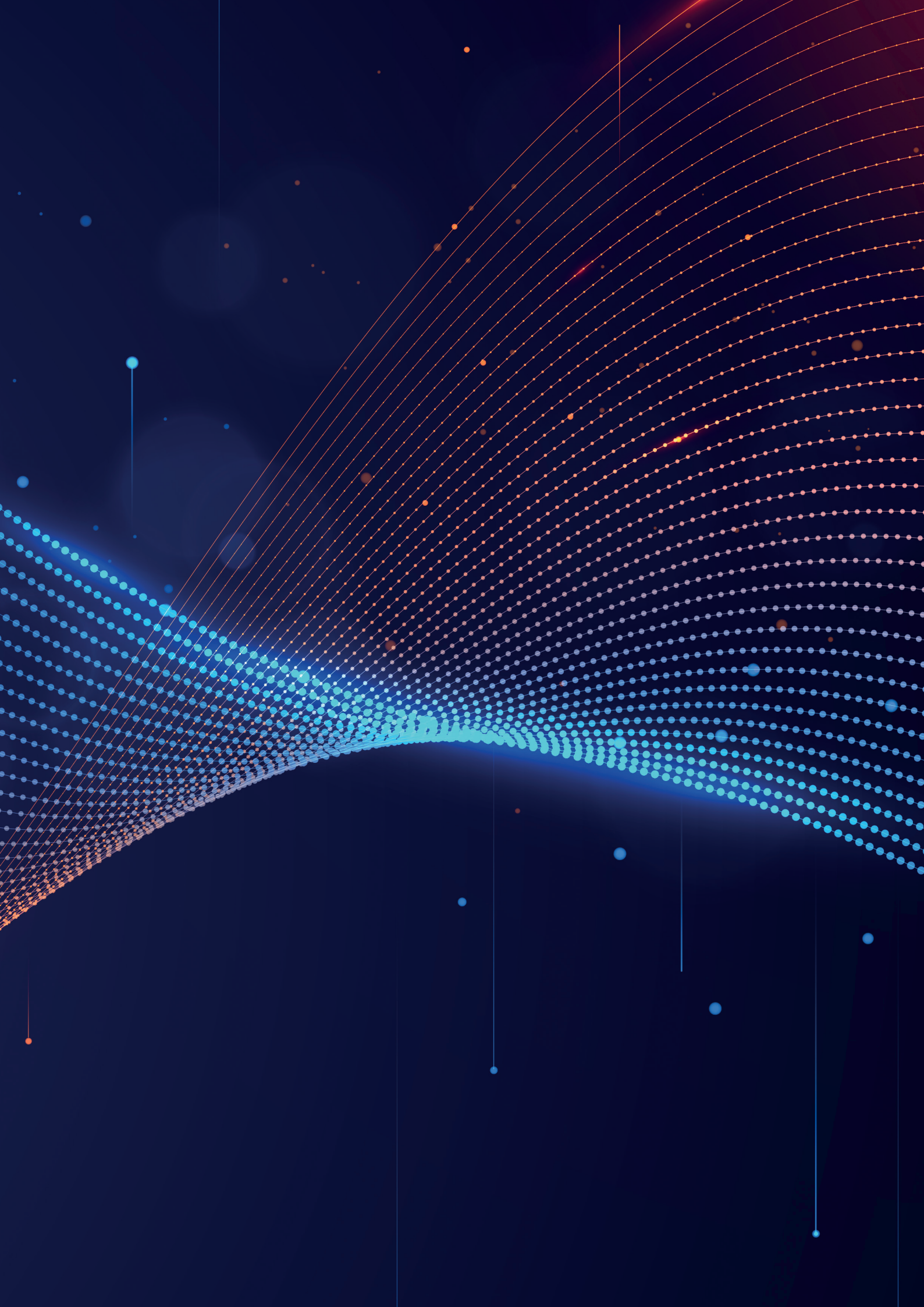

LED LIGHTING PRODUCTS AYDINLATMA ÜRÜNLERİ



MAKEL Elektrik Malzemeleri San. ve Tic. A.Ş.
Osmangazi Mah. Mareşal Fevzi Çakmak Cad.
No: 38 34522 Esenyurt - İSTANBUL
Tel: +90 (212) 689 50 50 (pbx)
Fax: +90 (212) 689 50 61

 / MakelElektrik

 / Makel_Elektrik

 / MakelElektrik

www.makel.com.tr • makel@makel.com.tr

TR-R01255 / 2019-11 / BA-1000

